

Going into 3rd Grade

Summer Practice Packet

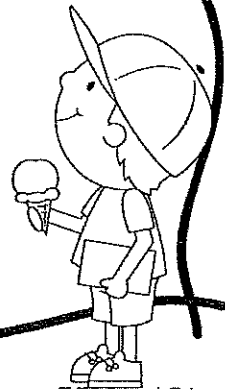

Today, we are going to practice **double digit subtraction.**

Day 2

$$\begin{array}{r} 53 \\ - 27 \\ \hline \end{array}$$

$$\begin{array}{r} 72 \\ - 38 \\ \hline \end{array}$$

$$\begin{array}{r} 43 \\ - 27 \\ \hline \end{array}$$

$$\begin{array}{r} 52 \\ - 36 \\ \hline \end{array}$$

$$\begin{array}{r} 98 \\ - 69 \\ \hline \end{array}$$

$$\begin{array}{r} 38 \\ - 25 \\ \hline \end{array}$$

$$\begin{array}{r} 22 \\ - 25 \\ \hline \end{array}$$

$$\begin{array}{r} 33 \\ - 25 \\ \hline \end{array}$$

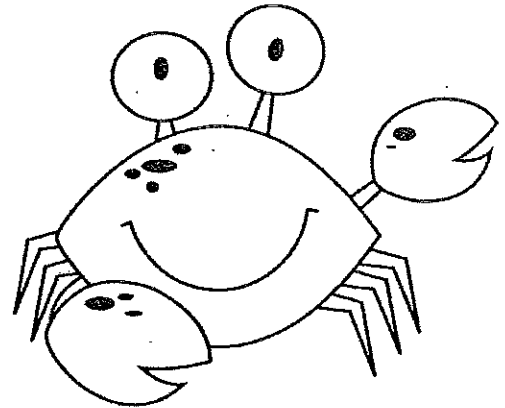

Today, we are going to practice **prefixes.**

Day 3

Write 3 words that begin with the prefix re-.

Write 3 words that begin with the prefix pre-.

Write 3 words that begin with the prefix un-.

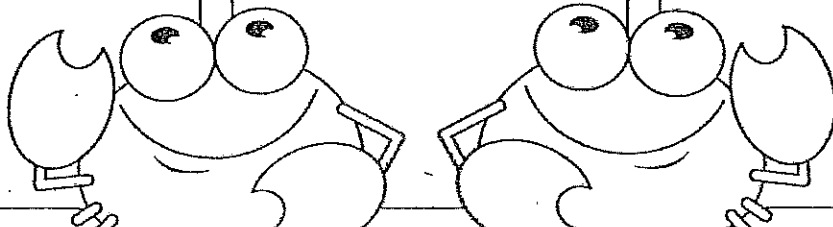

Today, we are going to practice
true and false facts.

Day 4

$17+5=22$

true false

$14+9=22$

true false

$26-8=16$

true false

$23-7=15$

true false

$24-6=18$

true false

$12+8=21$

true false



Today, we are going to practice
suffixes.

Day 5

Write 3 words
that end with
the suffix -er.

Write 3 words
that end with
the suffix -less.

Write 3 words
that end with
the suffix -ful.

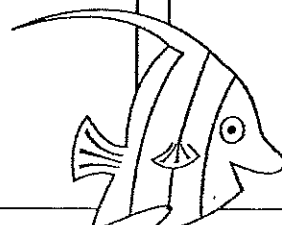
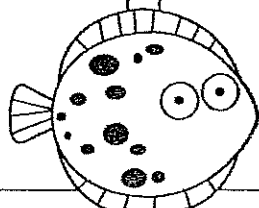

Today, we are going to practice
missing addends.

Day 6

$7 + \underline{\quad} = 14$

$\underline{\quad} + 10 = 16$

$6 + \underline{\quad} = 13$

$\underline{\quad} + 4 = 12$

$9 + \underline{\quad} = 17$

$\underline{\quad} + 11 = 19$

$12 + \underline{\quad} = 19$

$\underline{\quad} + 9 = 15$

$7 + \underline{\quad} = 12$

$\underline{\quad} + 4 = 11$

$9 + \underline{\quad} = 18$

$\underline{\quad} + 5 = 14$

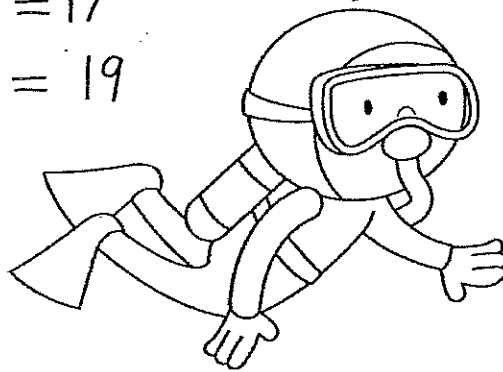

Today, we are going to practice
punctuation.

Day 7

Is it always sunny in the summer ___

The summer is the warmest season ___

I can't wait to jump in the cool pool ___

Did you call the lifeguard to see if it's open ___

I want to see my friends, but I am tired ___

We are going to the beach this year ___

How long until we need to put on our sunscreen ___

Wow, I can't believe the beach is this warm ___

Now, write your own QUESTION.

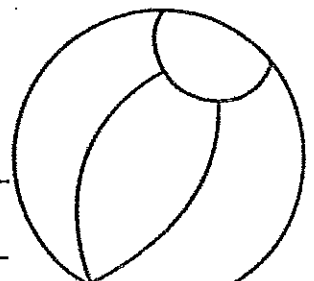

Today, we are going to practice
fact fluency.

Day 8

If you have a timer, time yourself. Solve these facts as fast as you can!

$$\begin{array}{r} 12 \\ -5 \\ \hline \end{array}$$

$$\begin{array}{r} 14 \\ +4 \\ \hline \end{array}$$

$$\begin{array}{r} 16 \\ -4 \\ \hline \end{array}$$

$$\begin{array}{r} 11 \\ +3 \\ \hline \end{array}$$

$$\begin{array}{r} 12 \\ -2 \\ \hline \end{array}$$

$$\begin{array}{r} 17 \\ -4 \\ \hline \end{array}$$

$$\begin{array}{r} 14 \\ +3 \\ \hline \end{array}$$

$$\begin{array}{r} 19 \\ -2 \\ \hline \end{array}$$

$$\begin{array}{r} 12 \\ +9 \\ \hline \end{array}$$

$$\begin{array}{r} 18 \\ -4 \\ \hline \end{array}$$

$$\begin{array}{r} 17 \\ +8 \\ \hline \end{array}$$

$$\begin{array}{r} 19 \\ -5 \\ \hline \end{array}$$

$$\begin{array}{r} 14 \\ +7 \\ \hline \end{array}$$

$$\begin{array}{r} 16 \\ -5 \\ \hline \end{array}$$

$$\begin{array}{r} 18 \\ +3 \\ \hline \end{array}$$

$$\begin{array}{r} 14 \\ -6 \\ \hline \end{array}$$



Today, we are going to practice
collective nouns.

Day 9

Circle the collective noun and underline the noun it is referring to.
Collective nouns are words for a group of specific items, animals, or people.

The school of fish swam by me in the ocean.

I saw a flock of seagulls fly in the sky.

I watched a TV show on a big pod of whales.

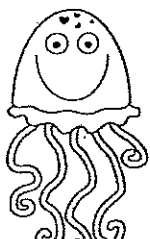

I do not want to get stuck in the middle of a smack of jellyfish.

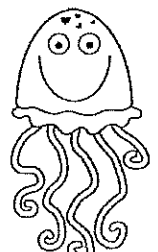

Today, we are going to practice
mental math.

Day 10

$254 + 400 = \underline{\hspace{2cm}}$

$256 - 100 = \underline{\hspace{2cm}}$

$965 + 200 = \underline{\hspace{2cm}}$

$753 + 200 = \underline{\hspace{2cm}}$

$356 - 100 = \underline{\hspace{2cm}}$

$856 - 400 = \underline{\hspace{2cm}}$

$105 + 500 = \underline{\hspace{2cm}}$

$425 - 200 = \underline{\hspace{2cm}}$

$746 + 100 = \underline{\hspace{2cm}}$

$388 + 300 = \underline{\hspace{2cm}}$

$655 - 200 = \underline{\hspace{2cm}}$

$952 - 600 = \underline{\hspace{2cm}}$

$352 + 500 = \underline{\hspace{2cm}}$

$144 + 700 = \underline{\hspace{2cm}}$

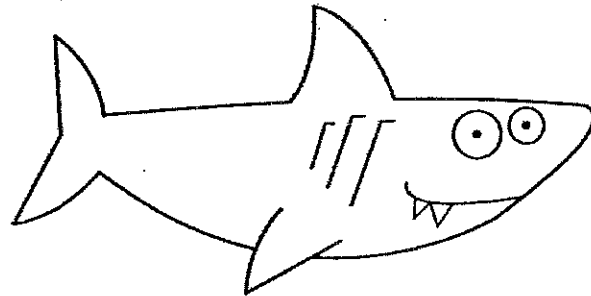

Today, we are going to practice
irregular verbs.

Day 11

verb	past tense
swim	
write	
fly	
run	

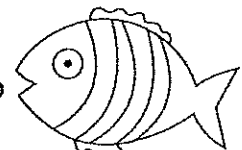

Today, we are going to practice **telling time.**

Day 12

What time is Ben going surfing?

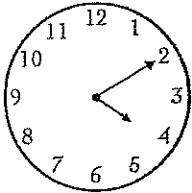

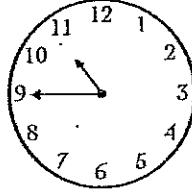

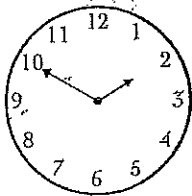

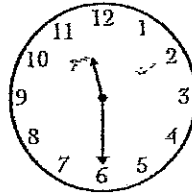

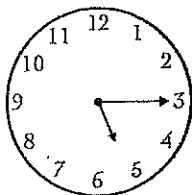

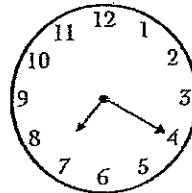



Today, we are going to practice **irregular nouns**

Day 13

1 fish

2

1 man

2

1 person

2

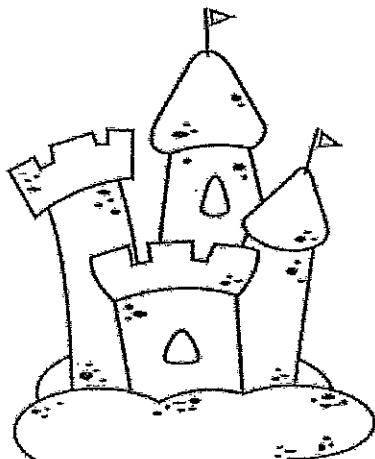

1 child

2

1 leaf

2

Today, we are going to practice
counting money.

Day 14

How much money did you find under the umbrella?

Today, we are going to practice
10 more and 100 less.

Day 15

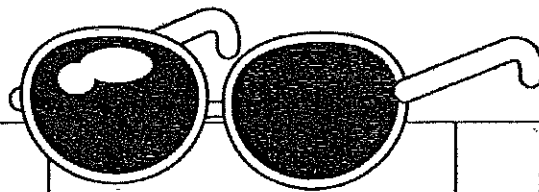

10 less		10 more
	135	
	257	
	391	
	540	
	828	
	619	

Today, we are going to practice **word problems.**

Day 16

My brother and I were looking for starfish on the beach. He found 37, but I only found 25. How many did we find in all?

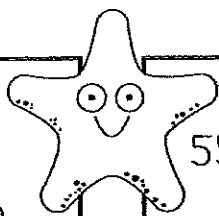

My family collected 55 starfish all together. On the way home, we dropped 18 starfish. How many starfish did we have left?

_____ = _____

_____ = _____

©Tobin, May 2015

Today, we are going to practice **expanding sentences.**

Day 17

The water is clear.

Fix these boring sentences.

The fish swam.

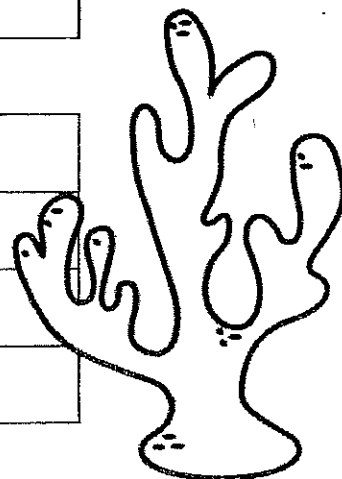

©Tobin, May 2015

Today, we are going to practice **expanded notation.**

Day 18

251	
+	+

486	
+	+

337	
+	+

540	
+	+

759	
+	+

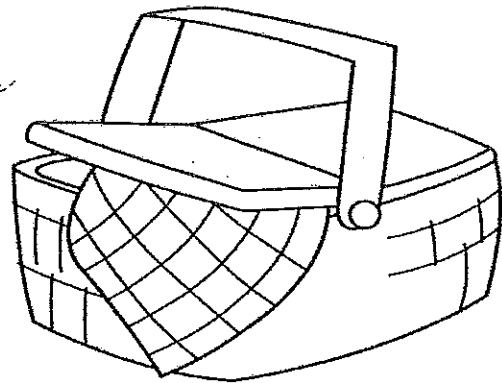

638	
+	+

©Tobin, May 2015

Today, we are going to practice **timed fluency.**

Day 19

If you have a timer, time yourself. Solve these facts as fast as you can!

$$\begin{array}{r} 17 \\ +3 \\ \hline \end{array}$$

$$\begin{array}{r} 15 \\ +6 \\ \hline \end{array}$$

$$\begin{array}{r} 13 \\ +4 \\ \hline \end{array}$$

$$\begin{array}{r} 14 \\ -3 \\ \hline \end{array}$$

$$\begin{array}{r} 15 \\ -7 \\ \hline \end{array}$$

$$\begin{array}{r} 15 \\ -8 \\ \hline \end{array}$$

$$\begin{array}{r} 13 \\ +8 \\ \hline \end{array}$$

$$\begin{array}{r} 12 \\ -8 \\ \hline \end{array}$$

$$\begin{array}{r} 13 \\ -7 \\ \hline \end{array}$$

$$\begin{array}{r} 9 \\ +8 \\ \hline \end{array}$$

$$\begin{array}{r} 10 \\ +8 \\ \hline \end{array}$$

$$\begin{array}{r} 14 \\ +7 \\ \hline \end{array}$$

$$\begin{array}{r} 15 \\ +4 \\ \hline \end{array}$$

$$\begin{array}{r} 13 \\ -5 \\ \hline \end{array}$$

$$\begin{array}{r} 19 \\ +9 \\ \hline \end{array}$$

$$\begin{array}{r} 17 \\ +8 \\ \hline \end{array}$$



©Tobin, May 2015

Today, we are going to practice **place value.**

Day 20

714		
Hundreds	Tens	Ones

508		
Hundreds	Tens	Ones

953		
Hundreds	Tens	Ones

266		
Hundreds	Tens	Ones

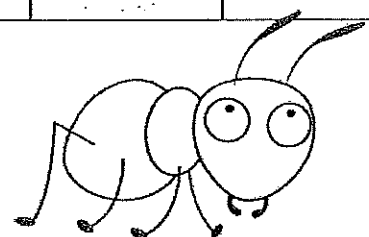
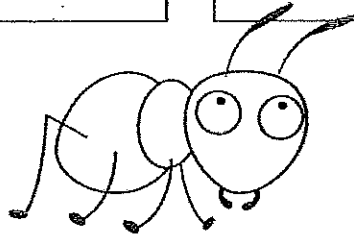
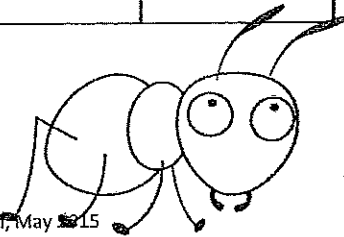

©Tobin, May 2015

Today, we are going to practice **capitalization.**

Day 21

monday, july 3, 2015

destin beach, florida

sally's souvenir shop

disney world

Rewrite these correctly.

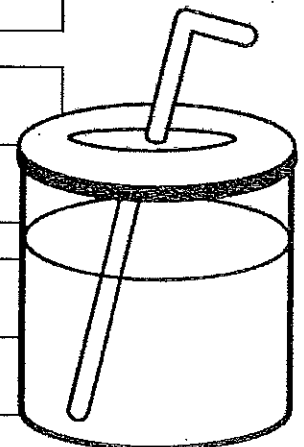

©Tobin, May 2015

Today, we are going to practice **graphs.**

Day 22

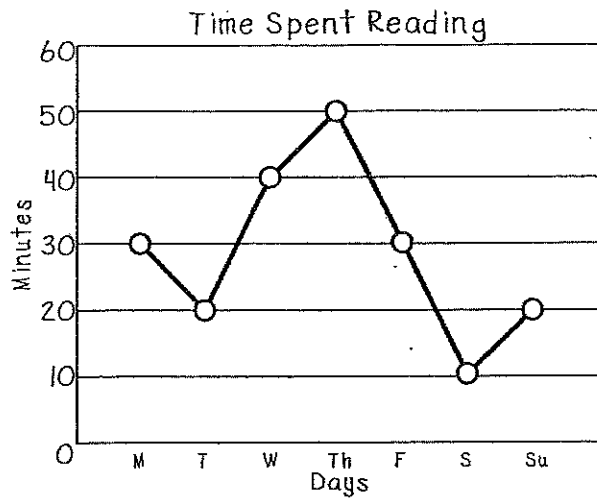

How long did she spend reading on Saturday? _____
How many more minutes did she read on Thursday than Tuesday?

How many minutes did she read on Friday, Saturday, and Sunday all together? _____

©Tobin, May 2015

Today, we are going to practice **writing a letter.**

Day 23

Write a letter to your teacher about your summer.

Dear _____

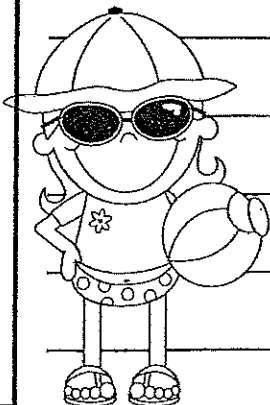

Sincerely,

Today, we are going to practice
comparing numbers.

Day 24

$219 \underline{\hspace{1cm}} 215$

$434 \underline{\hspace{1cm}} 474$

$55 \underline{\hspace{1cm}} 555$

$155 \underline{\hspace{1cm}} 157$

$918 \underline{\hspace{1cm}} 918$

$252 \underline{\hspace{1cm}} 225$

$446 \underline{\hspace{1cm}} 644$

$225 \underline{\hspace{1cm}} 252$

$479 \underline{\hspace{1cm}} 472$

$218 \underline{\hspace{1cm}} 281$

$135 \underline{\hspace{1cm}} 153$

$206 \underline{\hspace{1cm}} 602$

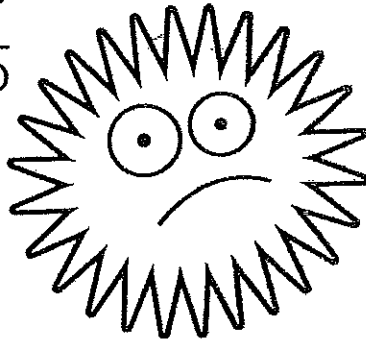

©Tobin, May 2015

Today, we are going to practice
partitioning shapes.

Day 25



Split this rectangle into
equal fourths.
Then, color one share.



Split this rectangle into
equal thirds.
Then, color one share.



Split this rectangle into
equal halves.
Then, color one share.

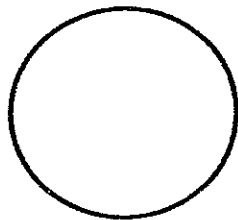

Split this circle into
equal fourths.
Then, color one share.

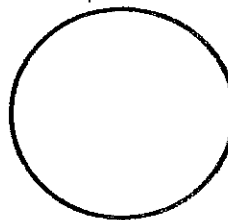

Split this circle into
equal thirds.
Then, color one share.

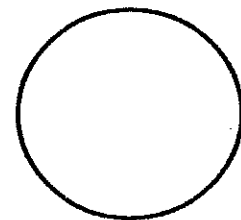

Split this circle into
equal halves.
Then, color one share.

©Tobin, May 2015

Today, we are going to practice
using commas in a series.

Day 26

The octopus was swimming through seashells
coral and seaweed.

He wanted to play with the shark the dolphin
and the jellyfish.

The octopus looked down and
saw a snorkel a shark's tooth
and a plastic flipper.

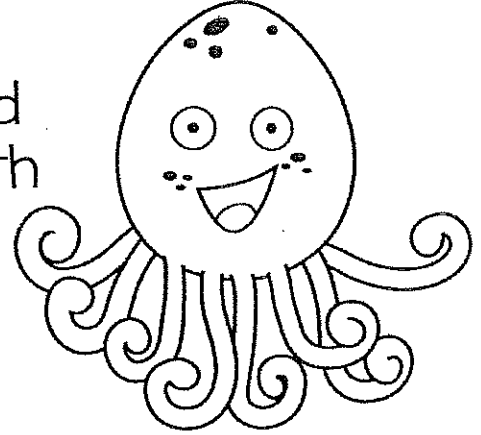

©Tobin, May 2015

Today, we are going to practice
3D shapes.

Day 27

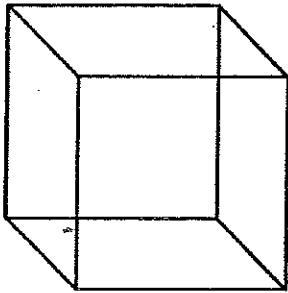

Faces:

Vertices:

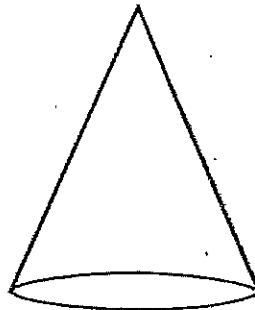

Faces:

Vertices:

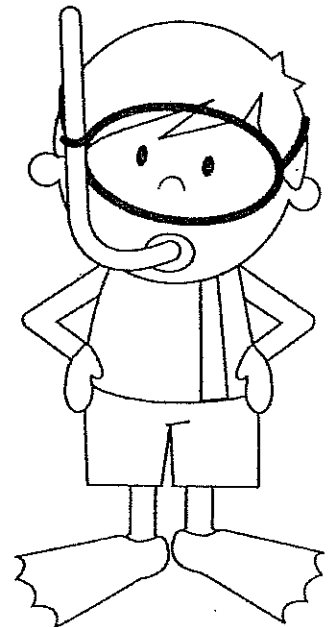

©Tobin, May 2015

Today, we are going to practice **contractions.**

Day 28

could not

I will

she has

will not

we have

he would

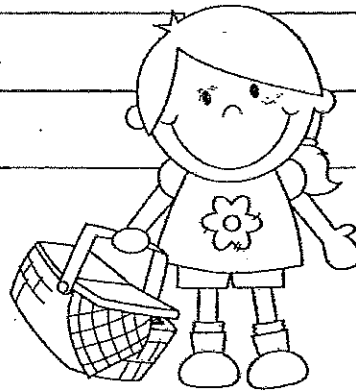

©Tobin, May 2015

Today, we are going to practice **nouns, verbs, and adjectives.**

Day 29

Circle the nouns.
Underline the verbs.
Put a squiggle line under the adjectives.

My smart mom told me that strong sunscreen helps your body stay healthy. The bright sun can burn my fair skin. Sunscreen helps prevent this. So, I will apply it every eighty minutes. This will help my skin stay healthy and avoid painful sunburns.

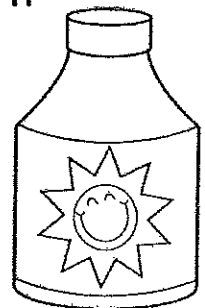

©Tobin, May 2015

Today, we are going to practice
double digit addition

Day 30

$$\begin{array}{r} 33 \\ + 25 \\ \hline \end{array}$$

$$\begin{array}{r} 52 \\ + 38 \\ \hline \end{array}$$

$$\begin{array}{r} 33 \\ + 27 \\ \hline \end{array}$$

$$\begin{array}{r} 50 \\ + 39 \\ \hline \end{array}$$

$$\begin{array}{r} 35 \\ + 56 \\ \hline \end{array}$$

$$\begin{array}{r} 38 \\ + 24 \\ \hline \end{array}$$

$$\begin{array}{r} 27 \\ + 27 \\ \hline \end{array}$$

$$\begin{array}{r} 39 \\ + 28 \\ \hline \end{array}$$

