

Second Grade Summer Packet

- Return in September during the 1st week of school
- Review all of your 1st grade sight words
- Take time to read to your child and visit the library
- Encourage your child to be a writer
- Practice math facts:
(addition & subtraction)

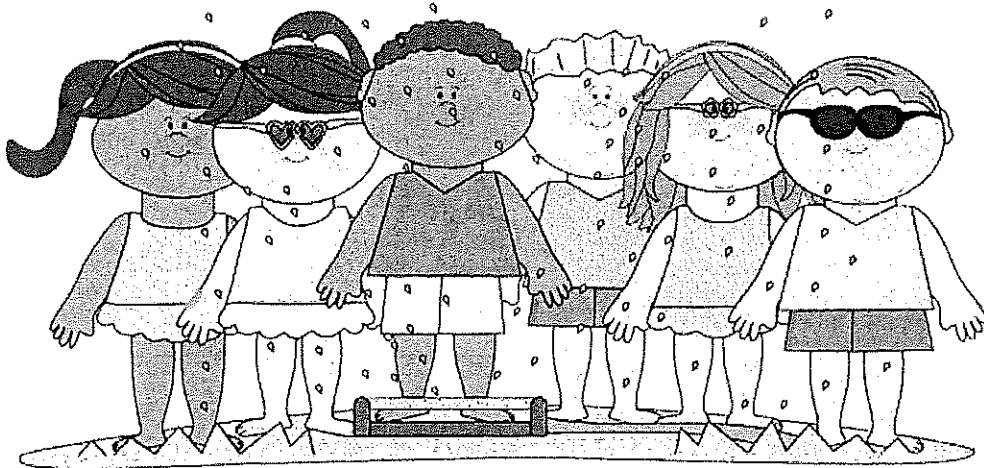

Today, we are going to practice
punctuation.

Day 1

Is it always sunny in the summer ___
The summer is the warmest season ___
I can't wait to jump in the cool pool ___
Did you call the lifeguard to see if it's open ___
I want to see my friends, but I am tired ___
We are going to the beach this year ___
How long until we need to put on our sunscreen ___
Wow, I can't believe the beach is this warm ___

Now, write your own QUESTION.

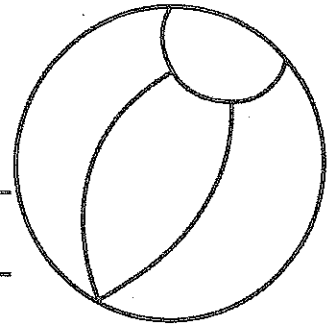

Today, we are going to practice
missing addends.

Day 2

$7 + \underline{\quad} = 14$

$10 + \underline{\quad} = 16$

$6 + \underline{\quad} = 13$

$4 + \underline{\quad} = 12$

$9 + \underline{\quad} = 17$

$11 + \underline{\quad} = 19$

$12 + \underline{\quad} = 19$

$9 + \underline{\quad} = 15$

$7 + \underline{\quad} = 12$

$4 + \underline{\quad} = 11$

$9 + \underline{\quad} = 18$

$5 + \underline{\quad} = 14$

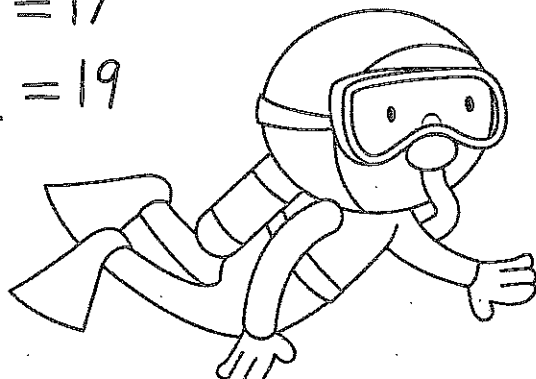

Today, we are going to practice
common and proper nouns.

Day 3

jellyfish	Common Noun
	Proper Noun

Daytona Beach	Common Noun
	Proper Noun

Smith's Surf Shop	Common Noun
	Proper Noun

Sydney, Australia	Common Noun
	Proper Noun

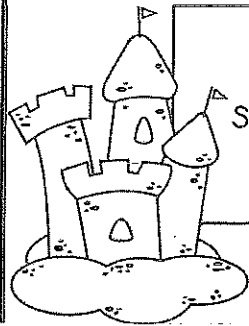

swimmer	Common Noun
	Proper Noun

surfboard	Common Noun
	Proper Noun

Today, we are going to practice
ten more and ten less.

Day 4

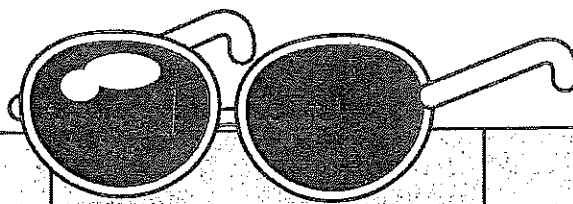

10 less		10 more
	35	
	57	
	91	
	40	
	28	
	19	

Today, we are going to practice
past tense.

Day 5

I will eat my sandwich at the picnic.

Rewrite
these
sentences
in the past
tense.

My mom will pack up the picnic basket.

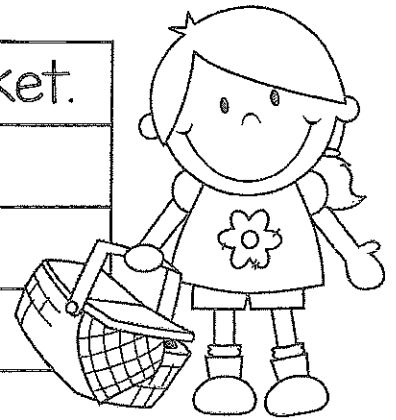

Today, we are going to practice
place value.

Day 6

71

Tens

Ones

58

Tens

Ones

93

Tens

Ones

26

Tens

Ones

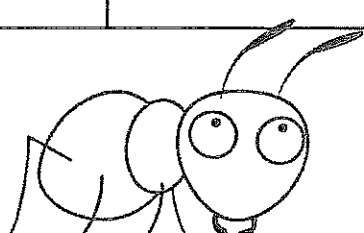
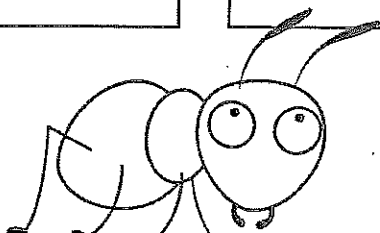
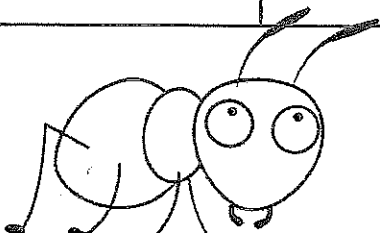

Today, we are going to practice **adjectives.**

Day 7

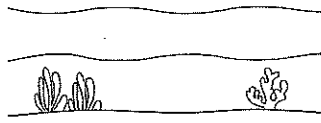

Write 5 adjectives to describe the ocean.

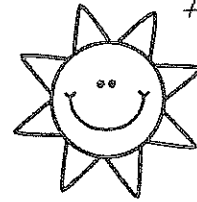

Write 5 adjectives to describe the sun.

Today, we are going to practice **counting to 120.**

Day 8

Count to 120 out loud 2 times and color the smiley face each time.

I can count to 120.

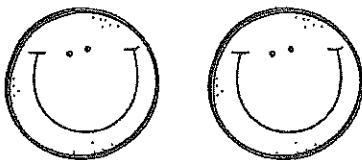

Now try it backwards.

I can count backwards from 120.

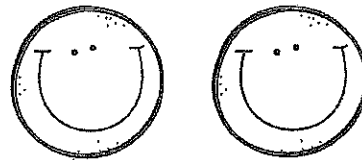

Today, we are going to practice **inflectional endings.**

Day 9

Word	-ed	-ing
play		
talk		
jump		
clean		

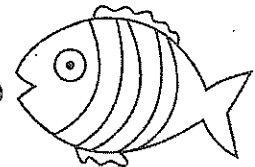
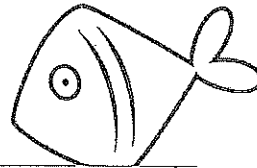
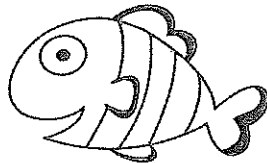
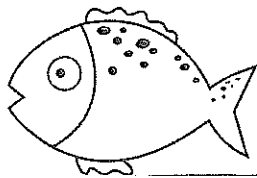

Today, we are going to practice **word problems.**

Day 10

My brother and I were looking for starfish on the beach. He found 17, but I only found 9. How many did we find in all?

=

My family collected 15 starfish all together. On the way home, we dropped 8 starfish. How many starfish did we have left?

=

Today, we are going to practice expanding sentences.

Day 11

The water is clear.

Fix these boring sentences.

The fish swam.

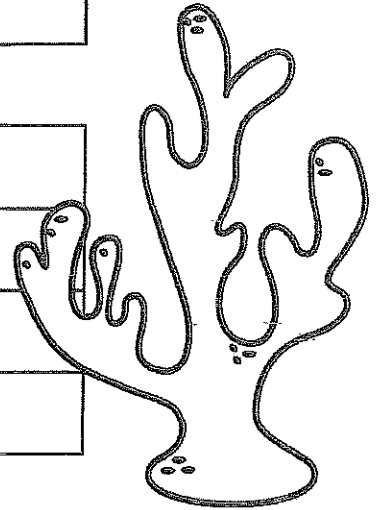

Today, we are going to practice adding.

Day 12

$$\begin{array}{r} 17 \\ +3 \\ \hline \end{array}$$

$$\begin{array}{r} 15 \\ +4 \\ \hline \end{array}$$

$$\begin{array}{r} 13 \\ +4 \\ \hline \end{array}$$

$$\begin{array}{r} 14 \\ +3 \\ \hline \end{array}$$

$$\begin{array}{r} 15 \\ +2 \\ \hline \end{array}$$

$$\begin{array}{r} 15 \\ +4 \\ \hline \end{array}$$

$$\begin{array}{r} 13 \\ +3 \\ \hline \end{array}$$

$$\begin{array}{r} 12 \\ +8 \\ \hline \end{array}$$

$$\begin{array}{r} 13 \\ +7 \\ \hline \end{array}$$

$$\begin{array}{r} 9 \\ +8 \\ \hline \end{array}$$

$$\begin{array}{r} 10 \\ +8 \\ \hline \end{array}$$

$$\begin{array}{r} 12 \\ +7 \\ \hline \end{array}$$

$$\begin{array}{r} 15 \\ +4 \\ \hline \end{array}$$

$$\begin{array}{r} 13 \\ +5 \\ \hline \end{array}$$

$$\begin{array}{r} 9 \\ +9 \\ \hline \end{array}$$

$$\begin{array}{r} 7 \\ +8 \\ \hline \end{array}$$

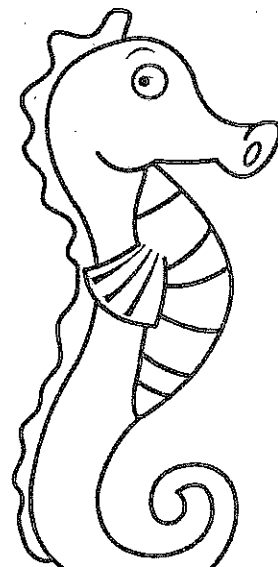

Today, we are going to practice **capitalization.**

Day 13

monday, july 3, 2015

destin beach, florida

sally's souvenir shop

disney world

Rewrite
these
correctly.

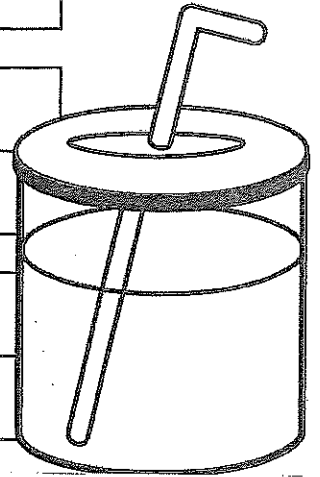

Today, we are going to practice **subtraction.**

Day 14

$$\begin{array}{r} 17 \\ -5 \\ \hline \end{array}$$

$$\begin{array}{r} 18 \\ -4 \\ \hline \end{array}$$

$$\begin{array}{r} 17 \\ -4 \\ \hline \end{array}$$

$$\begin{array}{r} 19 \\ -3 \\ \hline \end{array}$$

$$\begin{array}{r} 16 \\ -2 \\ \hline \end{array}$$

$$\begin{array}{r} 17 \\ -4 \\ \hline \end{array}$$

$$\begin{array}{r} 12 \\ -3 \\ \hline \end{array}$$

$$\begin{array}{r} 15 \\ -2 \\ \hline \end{array}$$

$$\begin{array}{r} 15 \\ -9 \\ \hline \end{array}$$

$$\begin{array}{r} 12 \\ -4 \\ \hline \end{array}$$

$$\begin{array}{r} 11 \\ -8 \\ \hline \end{array}$$

$$\begin{array}{r} 18 \\ -5 \\ \hline \end{array}$$

$$\begin{array}{r} 14 \\ -4 \\ \hline \end{array}$$

$$\begin{array}{r} 15 \\ -5 \\ \hline \end{array}$$

$$\begin{array}{r} 17 \\ -3 \\ \hline \end{array}$$

$$\begin{array}{r} 16 \\ -6 \\ \hline \end{array}$$

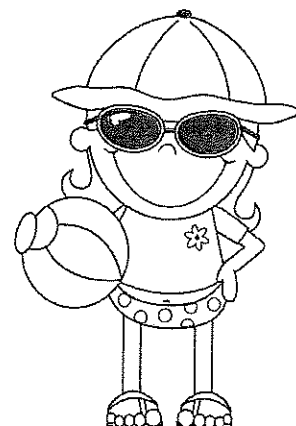

Today, we are going to practice
long and short vowels.

Day 15

Long Vowels

Short Vowels

Word Bank

grass
ice cream
air
swim
flip
beach
June
sand
picnic
road
sea
reading



©Tobin, May 2015

Today, we are going to practice
telling time.

Day 16

What time is Ben going surfing?

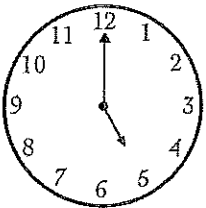

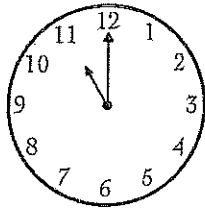

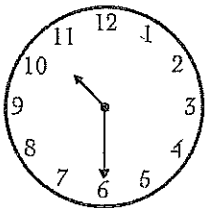

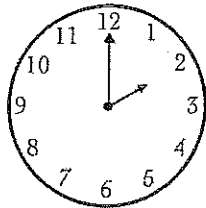

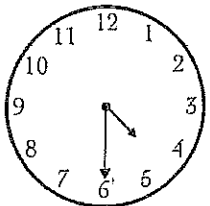

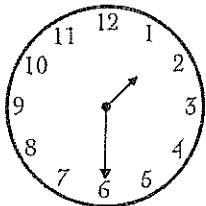



Today, we are going to practice **beginning blends.**

Day 17



im



eat

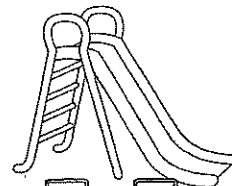

ide

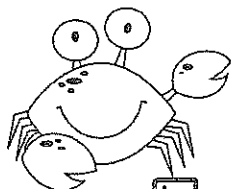

ab



ill

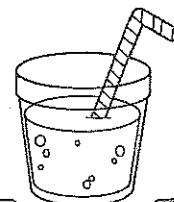

ink

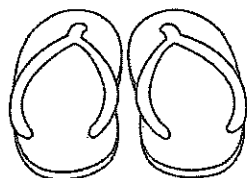

ip op



am



oat

©Tobin, May 2015

Today, we are going to practice **fact fluency.**

Day 18

If you have a timer, time yourself. Solve these facts as fast as you can!

$$\begin{array}{r} 12 \\ -5 \\ \hline \end{array}$$

$$\begin{array}{r} 14 \\ +4 \\ \hline \end{array}$$

$$\begin{array}{r} 16 \\ -4 \\ \hline \end{array}$$

$$\begin{array}{r} 11 \\ +3 \\ \hline \end{array}$$

$$\begin{array}{r} 12 \\ -2 \\ \hline \end{array}$$

$$\begin{array}{r} 17 \\ -4 \\ \hline \end{array}$$

$$\begin{array}{r} 14 \\ +3 \\ \hline \end{array}$$

$$\begin{array}{r} 19 \\ -2 \\ \hline \end{array}$$

$$\begin{array}{r} 12 \\ +9 \\ \hline \end{array}$$

$$\begin{array}{r} 18 \\ -4 \\ \hline \end{array}$$

$$\begin{array}{r} 17 \\ +8 \\ \hline \end{array}$$

$$\begin{array}{r} 19 \\ -5 \\ \hline \end{array}$$

$$\begin{array}{r} 14 \\ +7 \\ \hline \end{array}$$

$$\begin{array}{r} 16 \\ -5 \\ \hline \end{array}$$

$$\begin{array}{r} 18 \\ +3 \\ \hline \end{array}$$

$$\begin{array}{r} 14 \\ -6 \\ \hline \end{array}$$



Today, we are going to practice **ending blends.**

Day 19

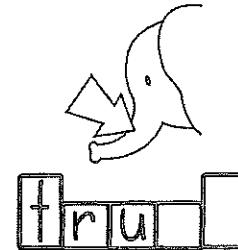
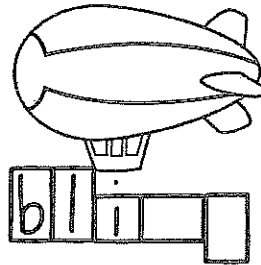
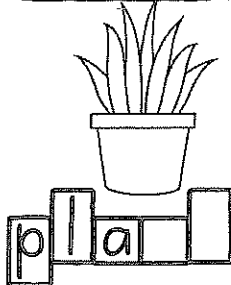
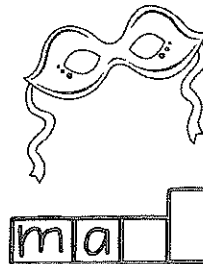
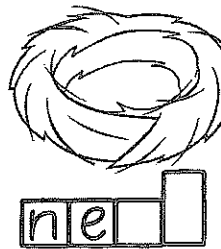
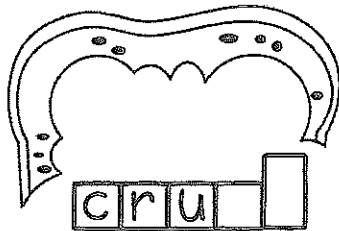
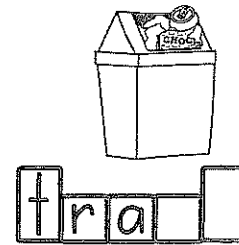
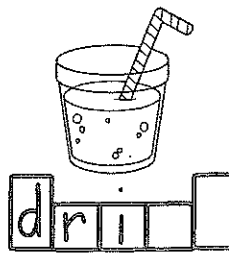
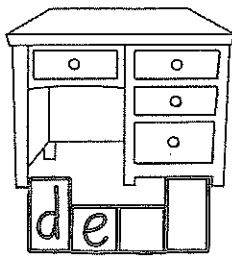

©Tobin, May 2015

Today, we are going to practice **graphs.**

Day 20

What did you eat for lunch?	
Sandwich	
Hot Dog	
Chicken	
Pizza	



How many kids ate chicken? _____

How many kids ate pizza and hot dogs? _____

What lunch food was eaten the least? _____

How many more kids ate pizza than a sandwich? _____

Today, we are going to practice compound words.

Day 21

Write the base words, then draw the base words.

cupcake		birdhouse	
↙	↘	↙	↘

©Tobin. May 2015

Today, we are going to practice partitioning shapes.

Day 22



Split this rectangle into equal fourths.
Then, color one share.



Split this rectangle into equal halves.
Then, color one share.

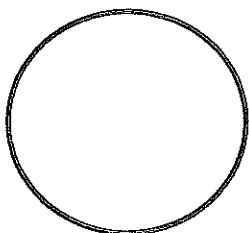

Split this circle into equal fourths.
Then, color one share.

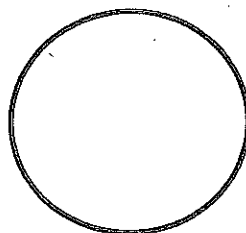

Split this circle into equal halves.
Then, color one share.

Today, we are going to practice **digraphs.**

Day 23

sh-

Draw a picture of something that begins with sh-.

ch-

Draw a picture of something that begins with ch-.

th-

Draw a picture of something that begins with th-.

©Tobin, May 2015

Today, we are going to practice **spelling words.**

Day 24

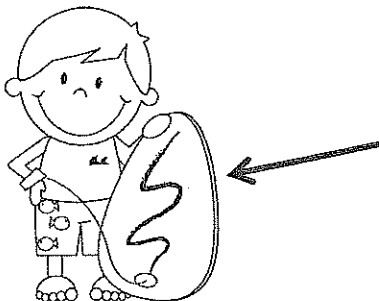
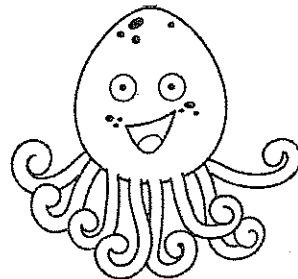
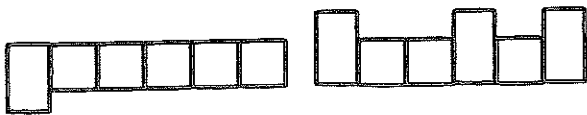
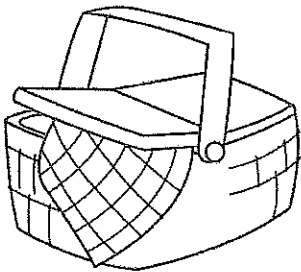

©Tobin, May 2015

Today, we are going to practice **double digit subtraction.**

Day 25

$$\begin{array}{r} 33 \\ - 20 \\ \hline \end{array}$$

$$\begin{array}{r} 72 \\ - 30 \\ \hline \end{array}$$

$$\begin{array}{r} 43 \\ - 20 \\ \hline \end{array}$$

$$\begin{array}{r} 52 \\ - 30 \\ \hline \end{array}$$

$$\begin{array}{r} 98 \\ - 60 \\ \hline \end{array}$$

$$\begin{array}{r} 38 \\ - 20 \\ \hline \end{array}$$

$$\begin{array}{r} 27 \\ - 20 \\ \hline \end{array}$$

$$\begin{array}{r} 39 \\ - 20 \\ \hline \end{array}$$

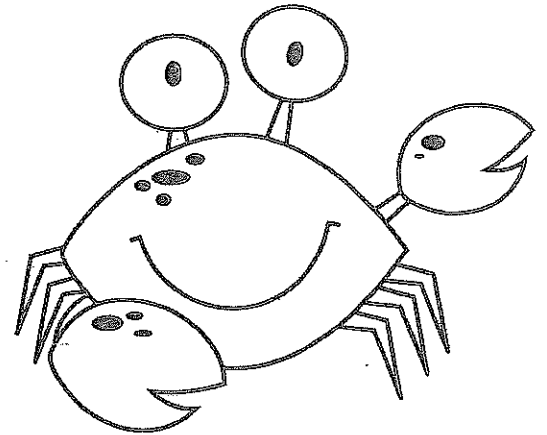

©Tobin, May 2015

Today, we are going to practice **making words.**

Day 26

summer vacation

©Tobin, May 2015

Today, we are going to practice
comparing numbers.

Day 27

$29 \underline{\hspace{1cm}} 25$

$34 \underline{\hspace{1cm}} 74$

$5 \underline{\hspace{1cm}} 55$

$15 \underline{\hspace{1cm}} 17$

$98 \underline{\hspace{1cm}} 98$

$52 \underline{\hspace{1cm}} 64$

$46 \underline{\hspace{1cm}} 64$

$25 \underline{\hspace{1cm}} 25$

$9 \underline{\hspace{1cm}} 19$

$28 \underline{\hspace{1cm}} 8$

$35 \underline{\hspace{1cm}} 24$

$26 \underline{\hspace{1cm}} 62$

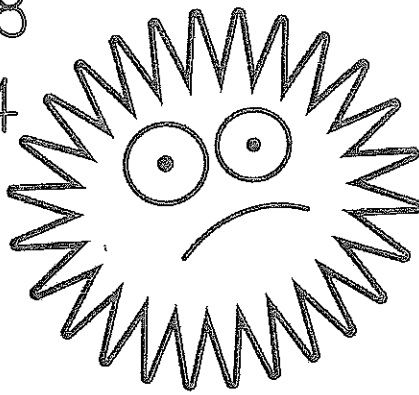

©Tobin, May 2015

Today, we are going to practice
place value.

Day 28

Circle the tens. Underline the ones

48 36 2 59 24 74 30

25 5 77 22 5 47 10

8 35 20 92 9 23 71

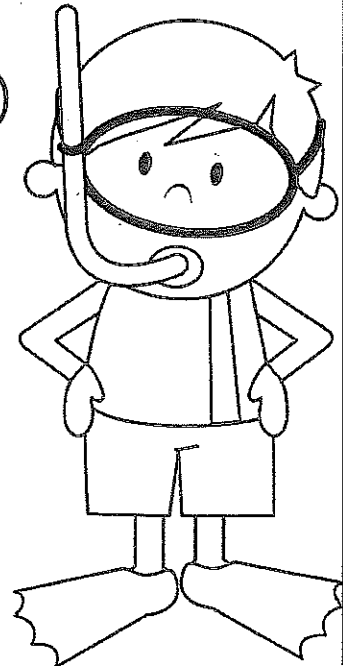

©Tobin, May 2015

Today, we are going to practice
double digit addition.

Day 29

$$\begin{array}{r} 33 \\ + 20 \\ \hline \end{array}$$

$$\begin{array}{r} 72 \\ + 30 \\ \hline \end{array}$$

$$\begin{array}{r} 43 \\ + 20 \\ \hline \end{array}$$

$$\begin{array}{r} 52 \\ + 30 \\ \hline \end{array}$$

$$\begin{array}{r} 98 \\ + 60 \\ \hline \end{array}$$

$$\begin{array}{r} 38 \\ + 20 \\ \hline \end{array}$$

$$\begin{array}{r} 27 \\ + 20 \\ \hline \end{array}$$

$$\begin{array}{r} 39 \\ + 20 \\ \hline \end{array}$$

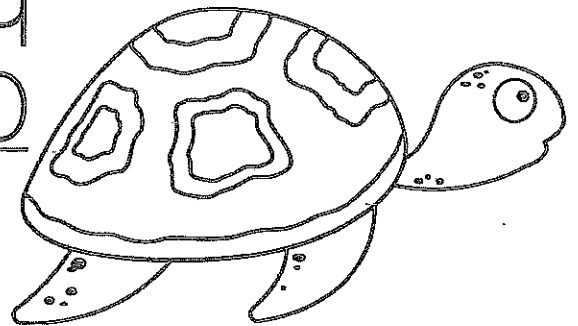

©Tobin, May 2015

Today, we are going to practice
nouns and verbs.

Day 30

Circle the nouns.
Underline the verbs.

Mom told me that sunscreen helps your body stay healthy. The sun can burn my skin.

Sunscreen helps prevent this. So, I will apply it every eighty minutes.

This will keep my skin healthy.

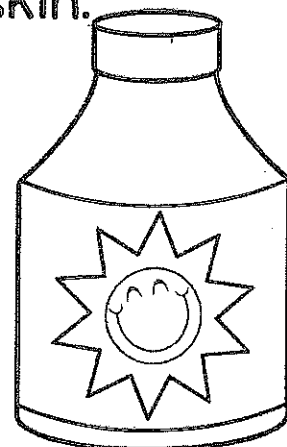

©Tobin, May 2015